

**2-Lines, Bi-directional, Transient Voltage Suppressors**

**Descriptions**

The ESD5432E is a 2-lines bi-directional TVS (Transient Voltage Suppressor). It is specifically designed to protect sensitive electronic components which are connected to power lines, low speed data lines and control lines from over-stress caused by ESD (Electrostatic Discharge), EFT (Electrical Fast Transients) and Lightning.

The ESD5432E may be used to provide ESD protection up to  $\pm 30\text{kV}$  (contact discharge) according to IEC61000-4-2, and withstand peak pulse current up to 10A (8/20 $\mu\text{s}$ ) according to IEC61000-4-5.

The ESD5432E is available in SOT-23 package. Standard products are Pb-free and Halogen-free.

**Features**

- Stand-off voltage:  $\pm 3.3\text{V}$  Max
- Transient protection for each line according to IEC61000-4-2 (ESD):  $\pm 30\text{kV}$  (contact discharge)  
IEC61000-4-4 (EFT): 40A (5/50ns)  
IEC61000-4-5 (surge): 10A (8/20 $\mu\text{s}$ )
- Capacitance:  $C_J = 17.5\text{pF}$  typ.
- Low leakage current:  $I_R = 1\text{nA}$  typ.
- Low clamping voltage:  $V_{CL} = 8\text{V}$  typ. @  $I_{PP} = 16\text{A}$  (TLP)
- Solid-state silicon technology

**Applications**

- Cellular handsets
- Computers and peripherals
- Microprocessors
- Power lines
- Portable Electronics
- Notebooks

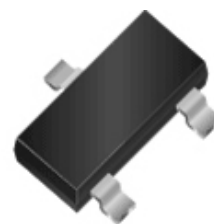

**SOT-23**

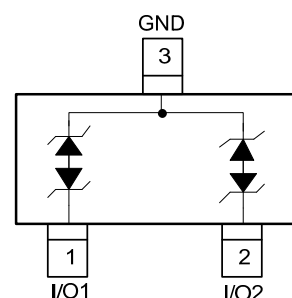

**Circuit diagram**

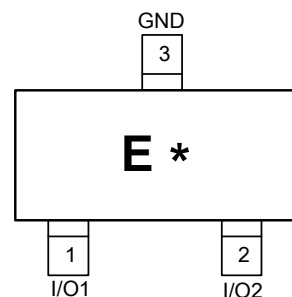

1 = Device code

\* = Month code ( A~Z)

**Marking (Top View)**

**Order information**

Device	Package	Shipping
ESD5432E-3/TR	SOT-23	3000/Tape&Reel

**Absolute maximum ratings**

Parameter	Symbol	Rating	Unit
Peak pulse power ( $t_p = 8/20\mu s$ )	$P_{pk}$	100	W
Peak pulse current ( $t_p = 8/20\mu s$ )	$I_{PP}$	10	A
ESD according to IEC61000-4-2 air discharge	$V_{ESD}$	$\pm 30$	kV
ESD according to IEC61000-4-2 contact discharge		$\pm 30$	
Operation junction temperature	$T_J$	125	$^{\circ}C$
Lead temperature	$T_L$	260	$^{\circ}C$
Storage temperature	$T_{STG}$	-55~150	$^{\circ}C$

**Electrical characteristics ( $T_A=25^{\circ}C$ , unless otherwise noted)**

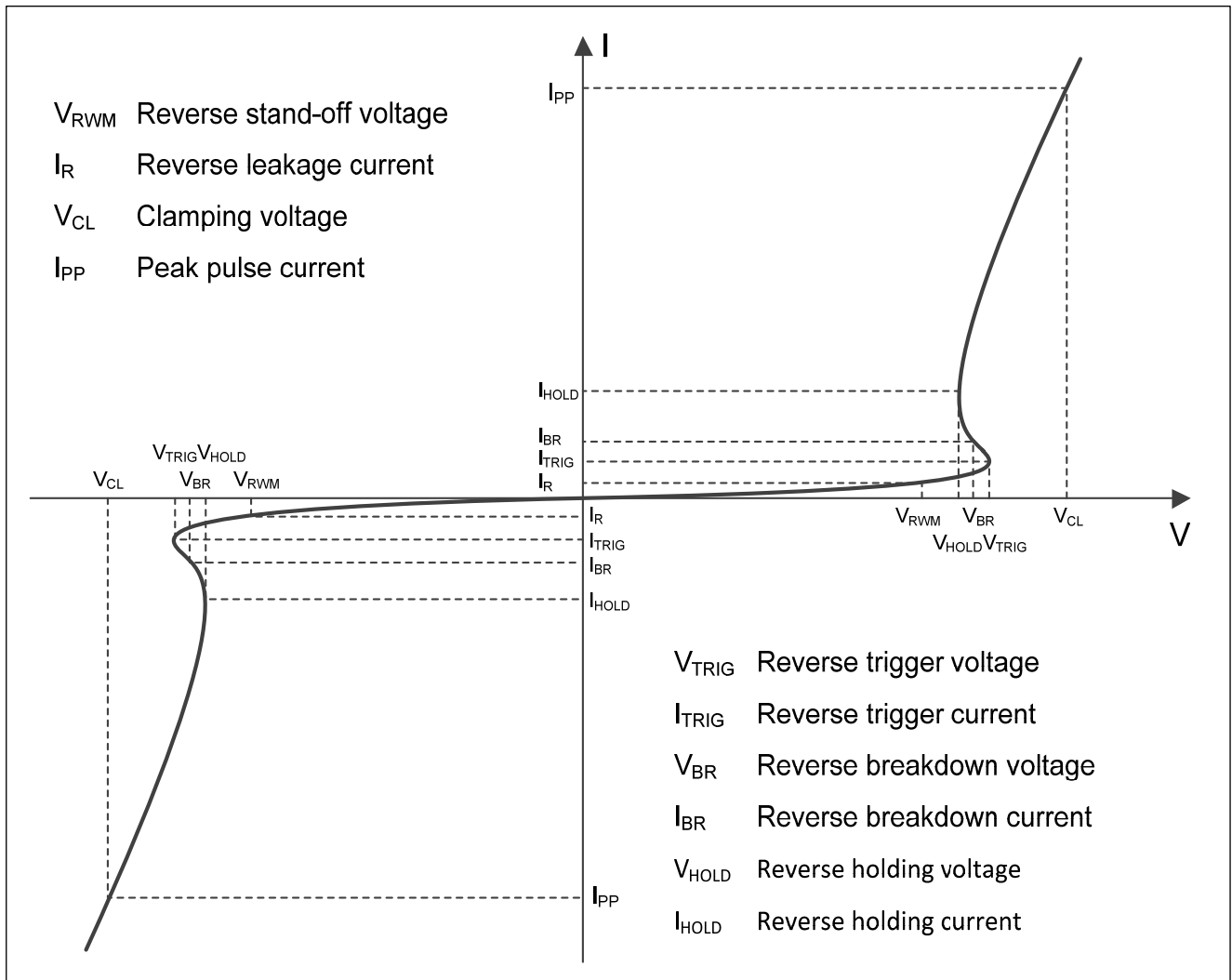

**Definitions of electrical characteristics**

**Electrical characteristics ( $T_A = 25^\circ\text{C}$ , unless otherwise noted)**

Parameter	Symbol	Condition	Min.	Typ.	Max.	Unit
Reverse stand-off voltage	$V_{RWM}$				$\pm 3.3$	V
Reverse leakage current	$I_R$	$V_{RWM} = 3.3\text{V}$		1	100	nA
Reverse breakdown voltage	$V_{BR}$	$I_{BR} = 1\text{mA}$	3.4			V
Reverse holding voltage	$V_{HOLD}$	$I_{HOLD} = 50\text{mA}$	3.4			V
Clamping voltage <sup>1)</sup>	$V_{CL}$	$I_{PP} = 16\text{A}$ , $t_p = 100\text{ns}$		8		V
Clamping voltage <sup>2)</sup>	$V_{CL}$	$V_{ESD} = 8\text{kV}$		8		V
Clamping voltage <sup>3)</sup>	$V_{CL}$	$I_{PP} = 1\text{A}$ , $t_p = 8/20\mu\text{s}$			6	V
		$I_{PP} = 5\text{A}$ , $t_p = 8/20\mu\text{s}$			8	V
		$I_{PP} = 10\text{A}$ , $t_p = 8/20\mu\text{s}$			10	V
Dynamic resistance <sup>1)</sup>	$R_{DYN}$			0.20		$\Omega$
Junction capacitance	$C_J$	$V_R = 0\text{V}$ , $f = 1\text{MHz}$ Any IO to GND		17.5	22	pF
		$V_R = 0\text{V}$ , $f = 1\text{MHz}$ Any IO to IO		9	12	pF

**Notes:**

- 1) TLP parameter:  $Z_0 = 50\Omega$ ,  $t_p = 100\text{ns}$ ,  $t_r = 2\text{ns}$ , averaging window from 60ns to 80ns.  $R_{DYN}$  is calculated from 4A to 16A.
- 2) Contact discharge mode, according to IEC61000-4-2.
- 3) Non-repetitive current pulse, according to IEC61000-4-5.

Typical characteristics ( $T_A = 25^\circ\text{C}$ , unless otherwise noted)

ESD5432E

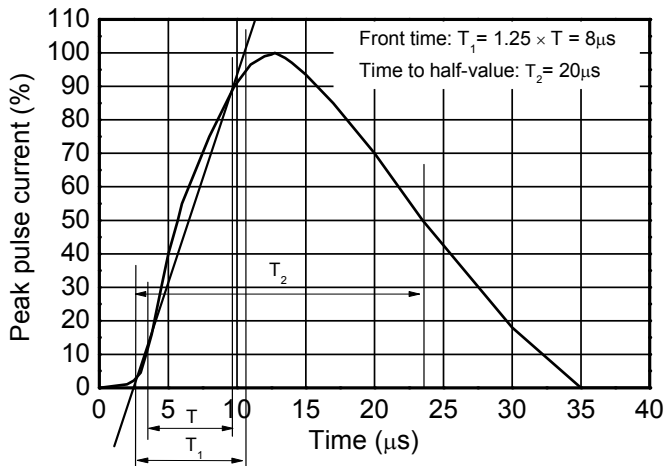

8/20 $\mu\text{s}$  waveform per IEC61000-4-5

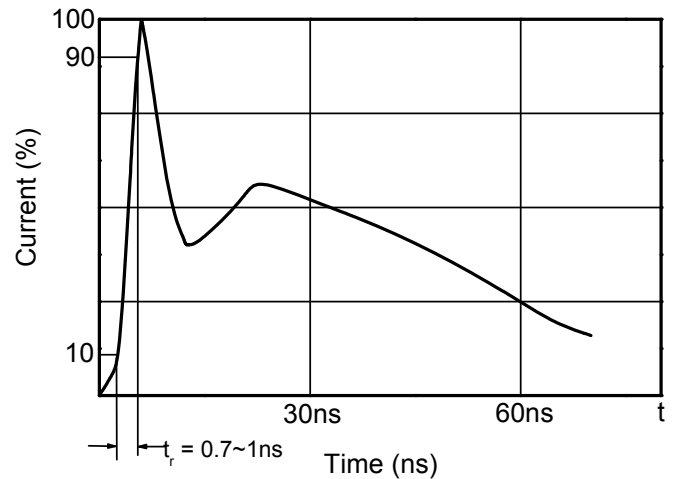

Contact discharge current waveform per IEC61000-4-2

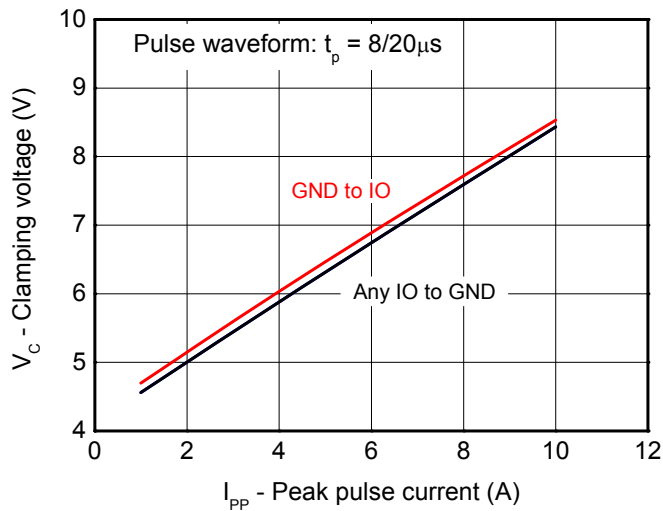

Clamping voltage vs. Peak pulse current

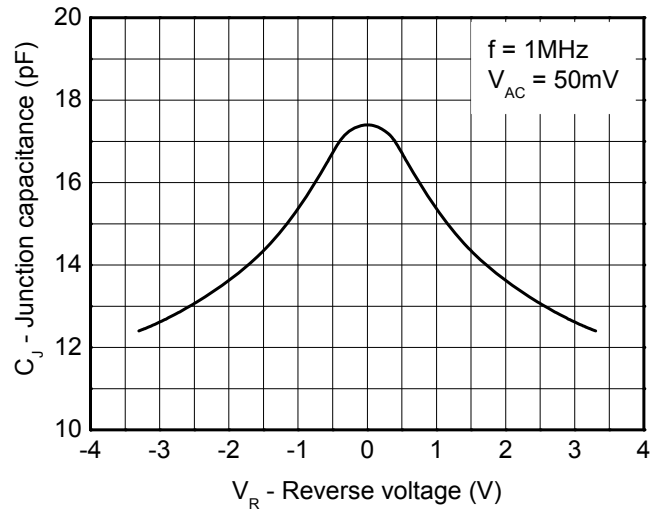

Capacitance vs. Reverses voltage

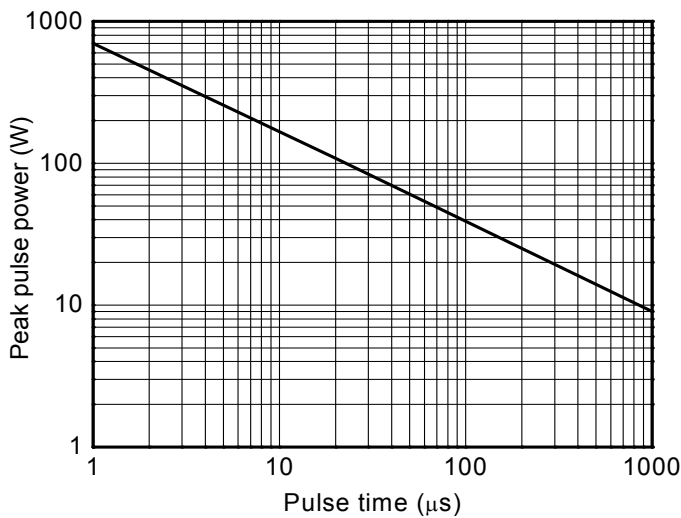

Non-repetitive peak pulse power vs. Pulse time

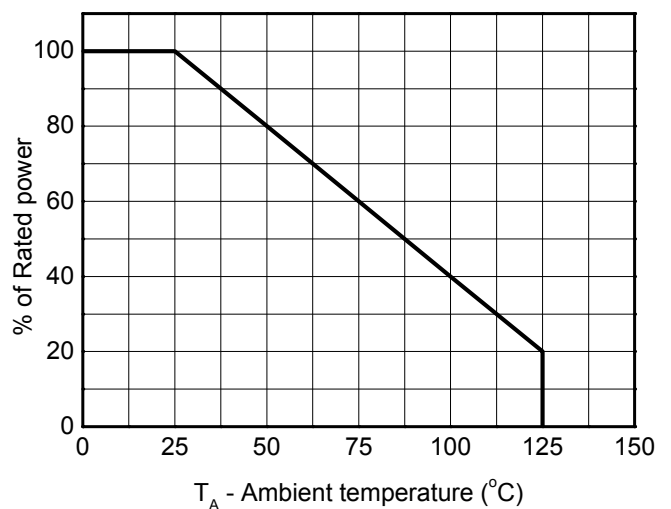

Power derating vs. Ambient temperature

Typical characteristics ( $T_A = 25^\circ\text{C}$ , unless otherwise noted)

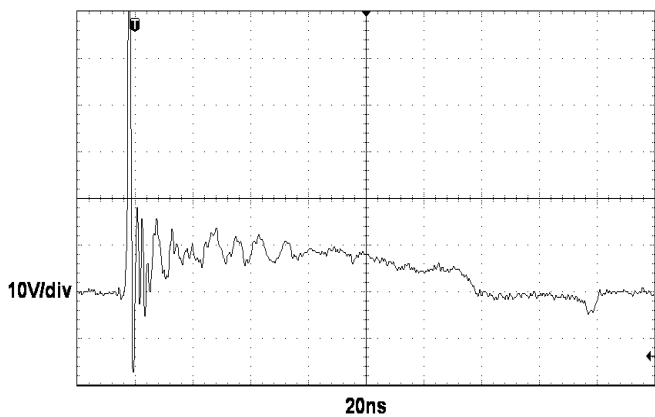

**ESD clamping**  
(+8kV contact discharge per IEC61000-4-2)

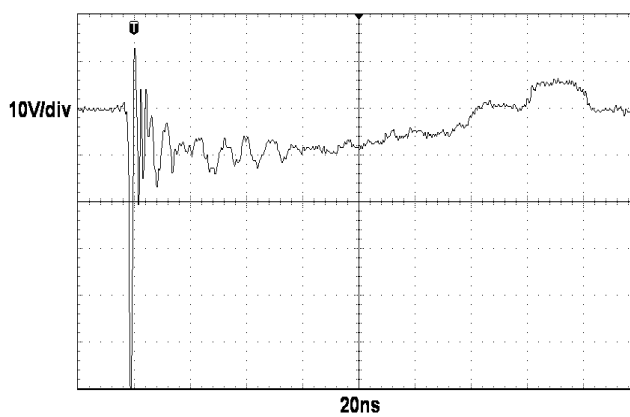

**ESD clamping**  
(-8kV contact discharge per IEC61000-4-2)

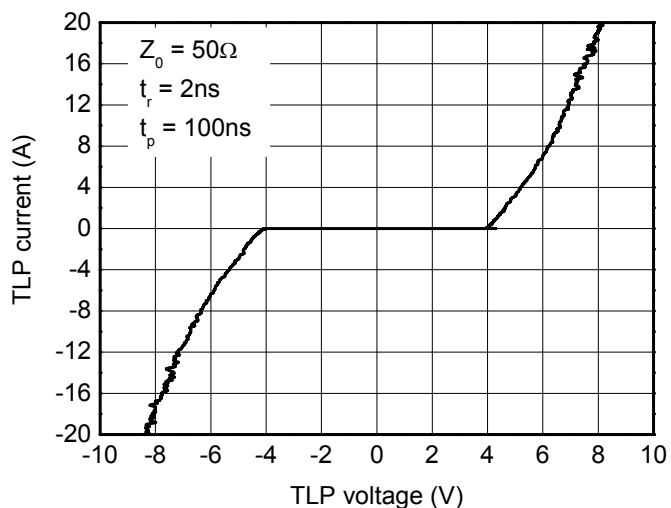

**TLP Measurement**

Package outline dimensions

SOT-23

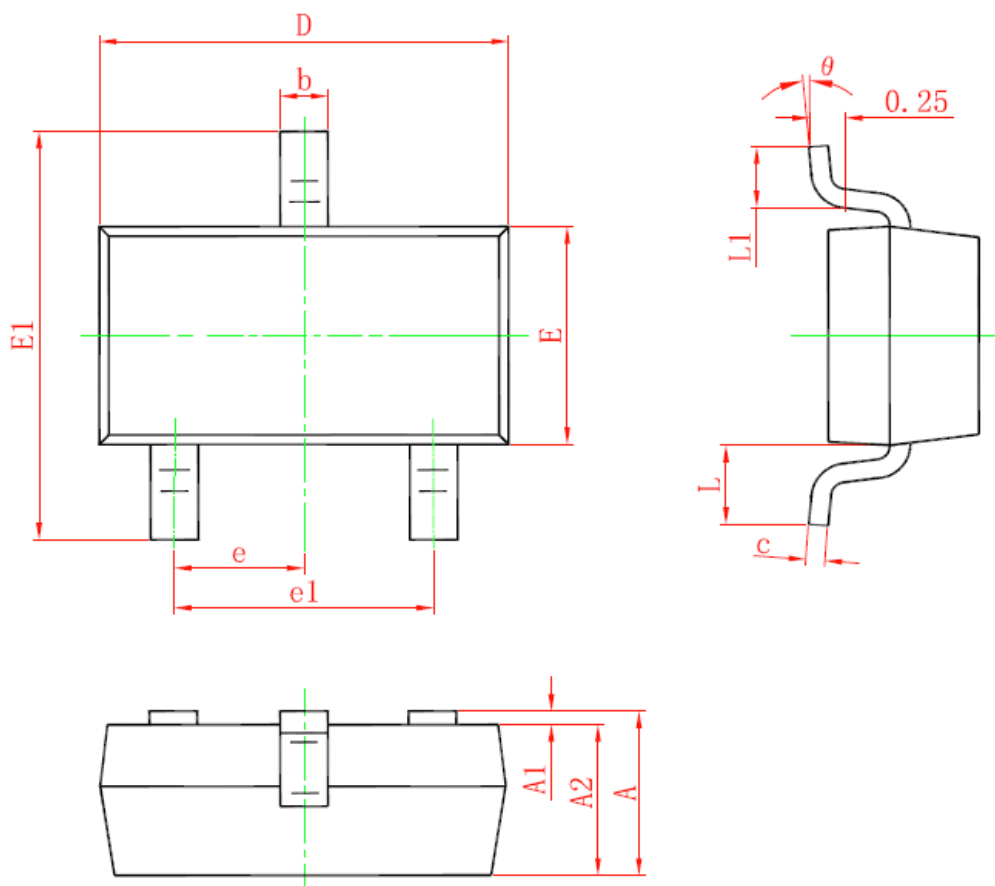

Symbol	Dimensions in millimeters		Dimensions in inches	
	Min.	Max.	Min.	Max.
A	0.900	1.150	0.035	0.045
A1	0.000	0.100	0.000	0.004
A2	0.900	1.050	0.035	0.041
b	0.300	0.500	0.012	0.020
c	0.080	0.150	0.003	0.006
D	2.800	3.000	0.110	0.118
E	1.200	1.400	0.047	0.055
E1	2.250	2.550	0.089	0.100
e	0.950TYP		0.037TYP	
e1	1.800	2.000	0.071	0.079
L	0.550REF		0.022REF	
L1	0.300	0.500	0.012	0.020
θ	0°	8°	0°	8°